



CENTAR ZA VOZILA HRVATSKE

---

# DANI TEHNIČKE ISPRAVNOSTI VOZILA 2011.

---

*Dani tehničke ispravnosti vozila 2011.*

Prosječna starost na TP vozila po kategorijama – 2010 g.

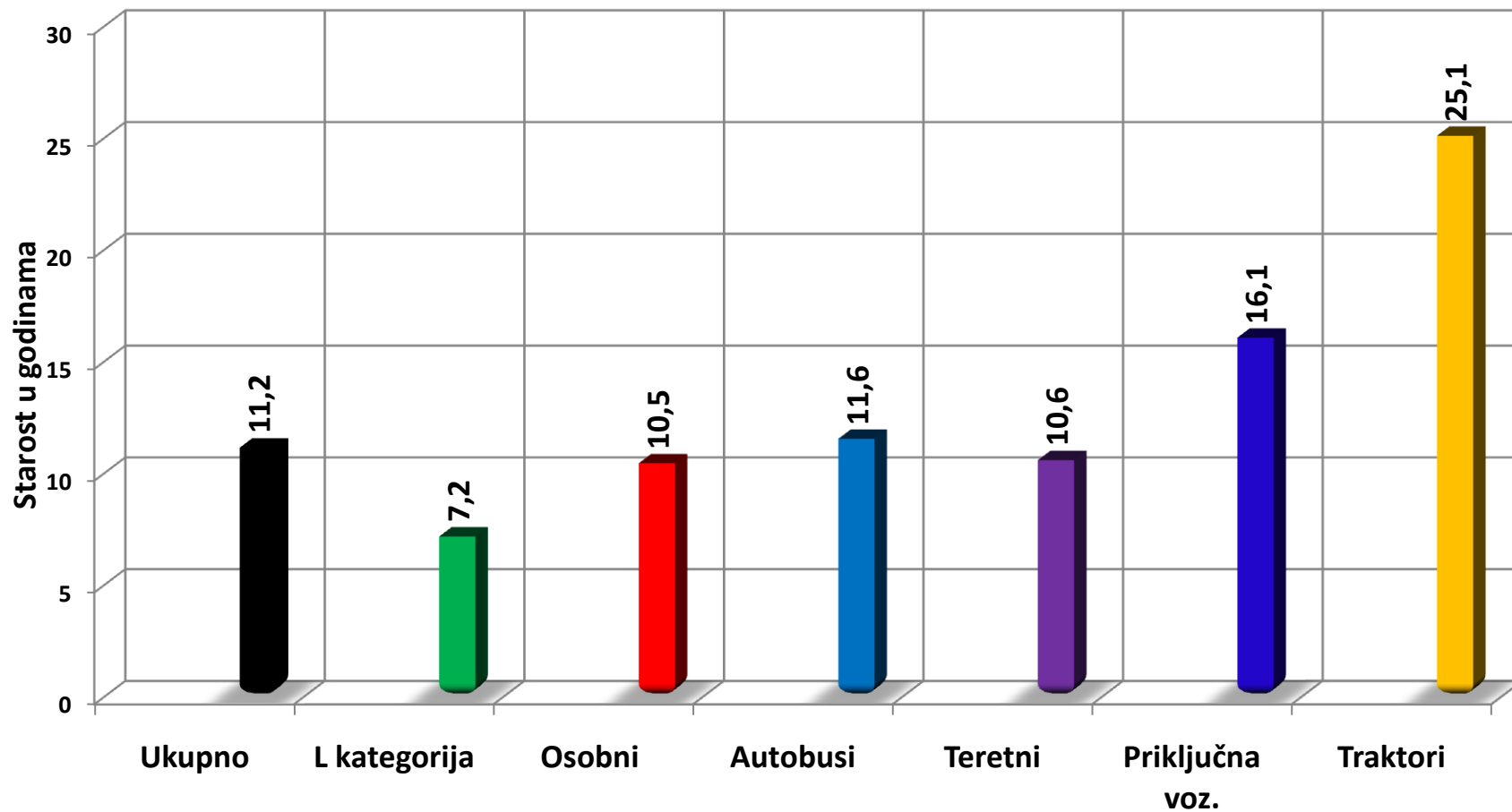

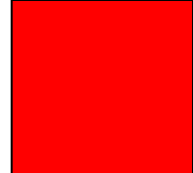

Postotak neispravnosti po kategorijama vozila, ovisno o starosti – 2010 g.

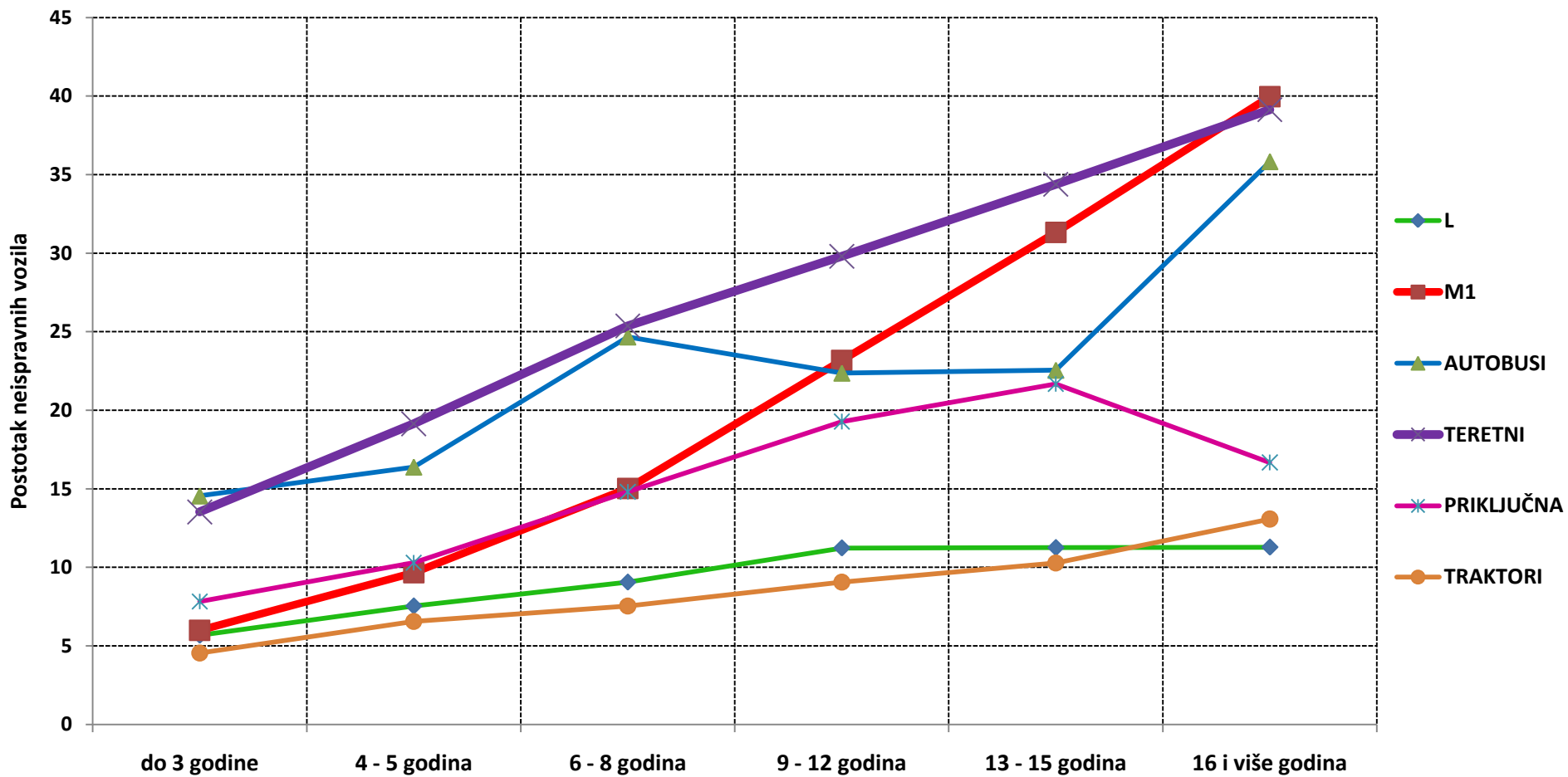

## Što ćemo kontrolirati:

- Opće stanje vozila
- Efikasnost kočnog sustava
- Donji postroj vozila
- Stanje ispušnih plinova
- Svjetlosno signalnu opremu
- Ostalo – po upitu vlasnika vozila

## Opće stanje vozila



*Dani tehničke ispravnosti vozila 2011.*

# Efikasnost kočnog sustava

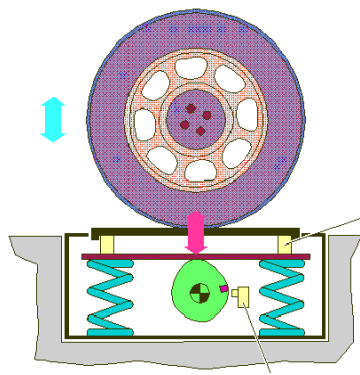
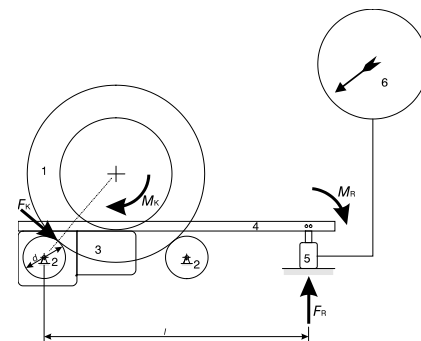

# Efikasnost amortizera



## Donji postroj vozila

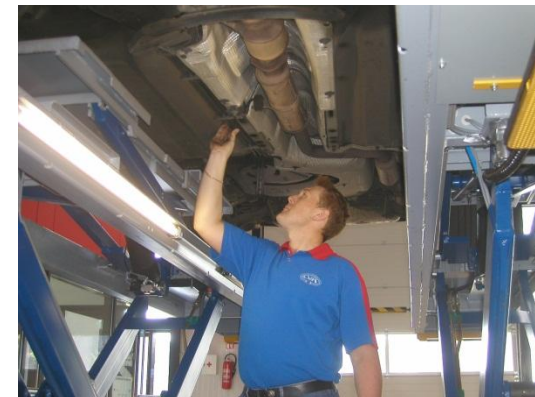

# Stanje ispušnih plinova

BENZIN

Zapamćena mjerenja: 1

|                 |       |           |       |
|-----------------|-------|-----------|-------|
| Br.okr. [r/min] | 780   | Ulje [°C] | 85    |
| CO [%vol]       | 0.115 | Lambda    | 0.997 |
|                 |       | HC [ppmv] | 154   |
| CO2 [%vol]      | 17.12 | O2 [%vol] | 0.18  |
|                 |       | NO [ppmv] | ----  |

ESC COcor Lista → << >>

Vrijednosti plina ( Benzin )

|                 |       |           |       |
|-----------------|-------|-----------|-------|
| Br.okr. [r/min] | 2410  | Ulje [°C] | 83    |
| CO [%vol]       | 0.068 | Lambda    | 1.003 |
|                 |       | HC [ppmv] | 38    |
| CO2 [%vol]      | 17.20 | O2 [%vol] | 0.16  |
|                 |       | NO [ppmv] | ----  |

ESC COcor → << >>

DIZEL

Rezultati ispitivanja

|                |             |      |      |      |
|----------------|-------------|------|------|------|
| Zacrnjenje [m] | 0.44        | 0.42 | 0.41 | ---- |
|                | ----        | ---- | ---- | ---- |
|                | ----        | ---- | ---- | ---- |
|                | ----        | ---- | ---- | ---- |
| k-srednje      | Šir. pojasa |      |      |      |
| 0.42 [m]       | 0.03 [m]    |      |      |      |

ESC → >>



## Svjetlosno signalna oprema

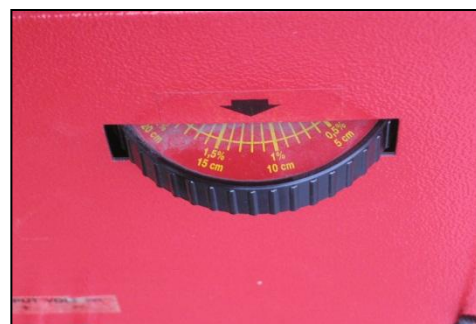



**HVALA NA POZORNOSTI**